

X *GYRO REMOTE CONTROL SERIES* **8HC 2.4G**

4-CHANNEL PRESSURE HOVERING HEIGHT-ADJUSTMENT REMOTE CONTROL 6-AXIS FLYCOPTER

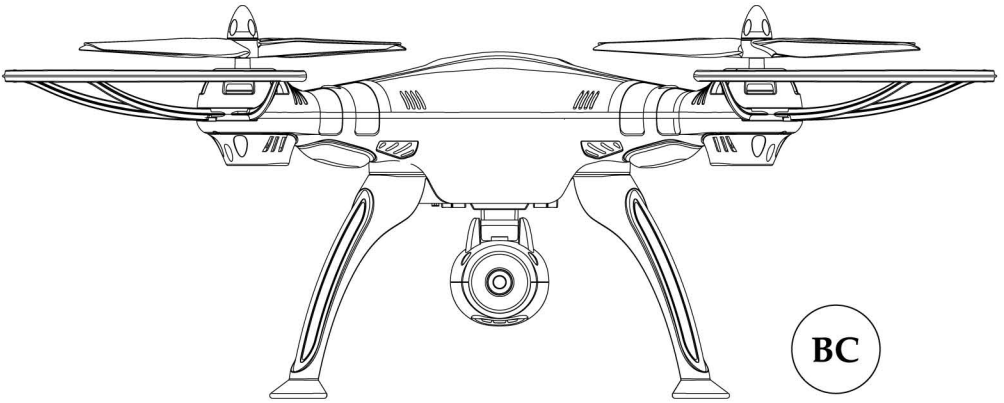

2

USER MANUAL

OPERATING STANDARDS: GB/T26701-2011

MAIN FEATURES

- Utilises the 4-axis structure, enabling the aircraft to be even more flexible, speedy, and possessing a relatively stronger wind-withstanding capability. Also it can conduct flights in interior as well as exterior environment.
- A 6-axis gyro direction stabiliser is built-in, ensuring precise positioning in the air.
- The structure uses modular designs, making installation simple and repair and maintenance easier.
- Capable of 360° 3D overturning function and fling-flying function.
- Headless function is enabling the aircraft to be summoned back with ease.
- Brand new pressure hovering height-adjustment function.

The content, specifications or accessory packaging of internal products in this user manual is strictly for reference only. Our company will not be responsible for errors in the printed contents and it will not be able to proactively notify the consumers. For any updates or errors, please abide by the SYMA MODEL AIRCRAFT's website as accurate.

Safety guide

1. Please store the smaller-sized aircraft accessories in places that are out of reach of children, in order to avoid the occurrence of accidents.
2. This aircraft is very powerful. For all first-time flight, it shall be observed that the left gear shift joystick must be slowly pushed in order to prevent the aircraft from ascending too quickly and result in unnecessary collision and damages.
3. When the flight is ended, the power supply of the remote control shall be switched off firstly, and then, followed by the switching off of the power supply of the aircraft.
4. Avoid placing the batteries in places with high temperatures and exposure to heat (for example, naked light or electrical equipment installations).
5. Take extra precaution to ensure that the aircraft is at a distance of 2 to 3 metres from the user or other people in order to prevent the aircraft from colliding into the head, face or body, etc. of other people during landing.
6. When young children are operating the aircraft, it shall be ensured that the adults are guiding and making sure that the aircraft control is within the viewing range of the controller (or instructor) such that it makes the control very convenient.
7. Non-rechargeable batteries are prohibited for recharging. When installing or changing the batteries, please take extra care on the polarities of the batteries; mixing new and old batteries or different types of batteries are strictly disallowed.
8. When the aircraft is not in use, please switch off the power supplies of both the aircraft and the remote control, and remove the batteries in the remote control.
9. The terminals & power supply cannot be short-circuited.

Repair and maintenance

1. Always use dry and soft cloth to clean this product.
2. Avoid this product to be exposed to sunlight or heat.
3. Avoid immersing these toys into water, otherwise ,the electronic parts may be damaged.
4. Regularly Check and inspect the plug and other accessories. If any damages are discovered, please immediately stop using it, until it is completely repaired in good working condition.

Package description

The following items can be found in this product package:

- Aircraft
- Remote Control
- Main Blade
- Instruction Manual
- Screwdriver
- Protection Gear
- Iron shaft
- Memory card
- Camera
- Card Reader
- Foot Stand
- Charger box
- Battery
- Screws (24 nos.)
- Blade lockstitch



Understanding your remote control

Remote control's button function description:

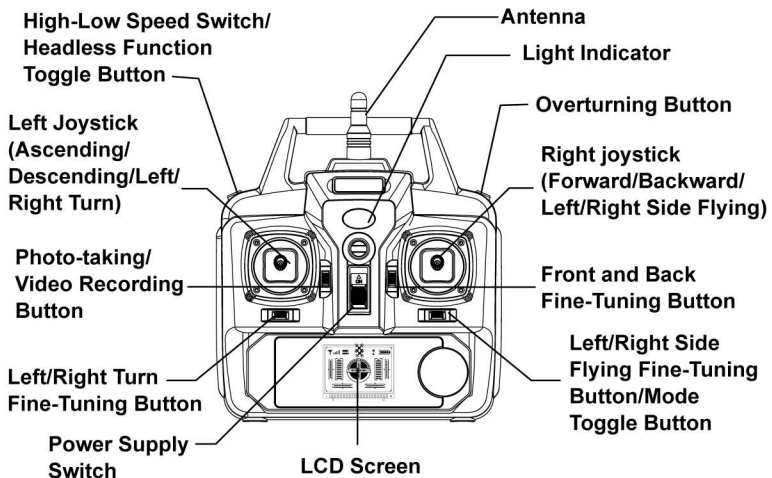

Battery installation for remote control:

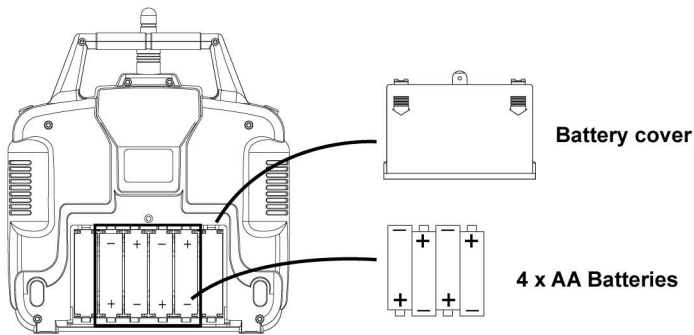

1. **Battery Installation Method:** Open up the battery cover at the back of the remote control. Correctly place 4 x AA alkaline batteries in the battery box in strict adherence to the polarity instructions (the batteries are optional).



1. During the battery installation, it must be ensured that the polarities of the batteries are matched with that of the battery box. No battery shall be installed with the opposite polarity.
2. Please do not use new and old batteries together.
3. Please do not use different types of batteries together.

Remote control button and lcd display functions description

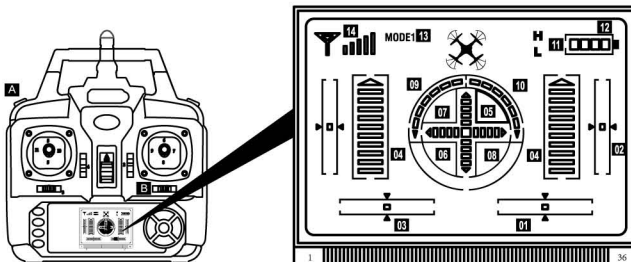

1. **Fine-tuning of left and right side flying:** After switching on the remote control, it is displayed at the middle point.
2. **Fine-tuning of forward and back:** After switching on the remote control, it is displayed at the middle point.
3. **Fine-tuning of left and right turning:** After switching on the remote control, it is displayed at the middle point.
4. **Accelerator Display:** After frequency-matching, it is displayed at the middle point.
5. **Forward Display:** When the right joystick is pushed forward, it will be gradually ascended; the forward speed of the aircraft will be gradually increased.
6. **Backward Display:** When the right joystick is pushed backward, it will be gradually ascended; the backward speed of the aircraft will be gradually increased.
7. **Left Side Flying Display:** When the right joystick is pushed to the left, it will be gradually ascended; the left side flying speed of the aircraft will be gradually increased.
8. **Right Side Flying Display:** When the right joystick is pushed to the right, it will be gradually ascended; the right side flying speed of the aircraft will be gradually increased.
9. **Left Turning Display:** When the left joystick is pushed to the left, it will be gradually ascended; the left turning speed of the aircraft will be gradually increased.
10. **Right Turning Display:** When the left joystick is pushed to the right, it will be gradually ascended; the right turning speed of the aircraft will be gradually increased.
11. **Fast-Slow Gear Display:** Press against Button A can enable the aircraft to execute the toggle of fast-slow gear. The fast gear is H, while the slow gear is L.
12. **Power Supply Display:** Display the current power capacity of the remote control.
13. **Mode Display:** The default is MODE1 upon starting up. Push the Button B to the right and switch on the power supply switch at the same time can toggle to MODE2.
14. **Signal Display:** Display the strong and weak signals.

Installation steps of quadcopter's safety guard



Figure 1

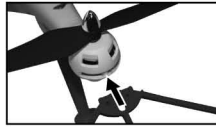

Figure 2



Figure 3

1. Pull out decorating parts as shown in figure (1).
2. Insert guard circle into the fuselage interface as shown in figure (2).
3. Twist two screws of every parts as shown in figure (3).

Note: Without blade protective frame,rolling effect in flight will be better.

Installation steps of quadcopter's stands

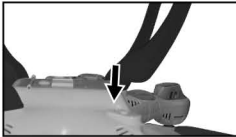

Figure 1



Figure 2

1. Insert stands into the quadcopter body as figure(1).
2. Twist the wide screws to locking the stands as figure(2).

Install camera

Installation camera steps :

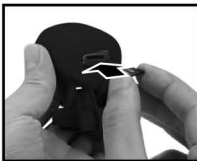

Figure 1

1. Figure (1) shows the memory card into the slot on the back of the camera.



Figure 2

2. Push the camera and tight it as figure (2).

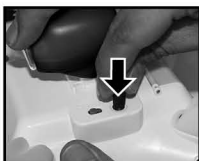

Figure 3

3. Connect the camera power line into the socket on quadcopter body as figure (3).

Disassembly camera steps:

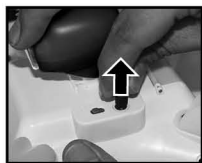

Figure 1

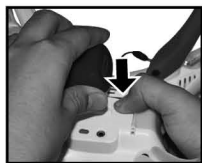

Figure 2



Figure 3

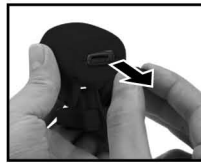

Figure 4

1. Pull out power supply cable of the camera as shown in Figure (1).
2. Press down safe lock of lower main body as shown in Figure (2).
3. Push forward the camera and take it out as shown in Figure (3).
4. Figure (4) shows the memory card from the camera pull the head.

Note: After turning on quadcopter's power supply, it forbids to insert or pull out the camera's plug connecting to the aircraft.

Aerial photo-taking function:

1. Method: A. Insert the plug connector of the camera into the specified aircraft's socket.

B. Open up the power supply of the aircraft. When the red light on the camera has turned green, it means the camera is in a normal operating mode. When the red light has turned off after lighting up and the green light is off, it means the SD card is not connected to the camera.

2. Description of photo-taking and video recording functions:

Photo-taking Function: When the camera is in the normal operating mode, press the “Photo-taking/ Video Recording Button” upwards and the remote control will issue a beep sound. When the photo-taking is completed, the red light indicator on the camera and the LED light on the aircraft will blink once.

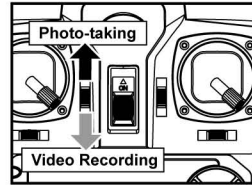

Video Recording Function: When the camera is in the normal operating mode, press the “Photo-taking/Video Recording Button” downwards and the remote control will issue two beep sounds. When the red light indicator on the camera and the LED light on the aircraft blink continuously, it means the video recording is in operation.

Pressing the button again will result in the red light turning green, indicating the video recording has just ended.

Aircraft operation guidance

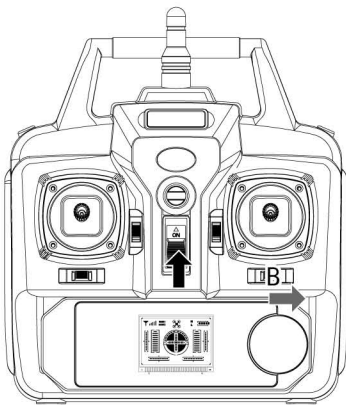

In order to satisfy the different operating habits of the consumers, this remote control is installed with two types of different operating modes, Mode 1 and Mode 2. Upon starting up, press Button B towards the right and switch on the power supply of the remote control simultaneously can toggle between Mode 1 and Mode 2.

Aircraft controlling diagram (mode 1 and default mode upon start-up)

Operating direction

Ascending and descending control

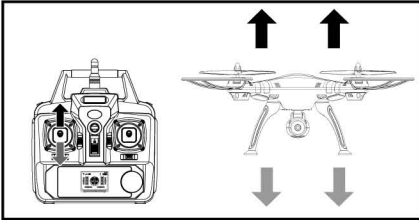

When the left joystick (Accelerator) is pushed upwards or downwards, the aircraft will ascend or descend correspondingly.

Forward and backward control

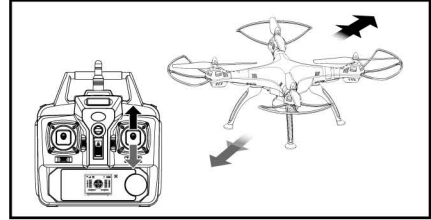

When the right joystick (Turning Rudder) is pushed upwards or downwards, the aircraft will advance forward or backward correspondingly.

Left turning and right turning control

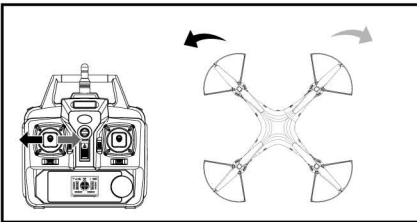

When the left joystick (Accelerator) is pushed towards the left or right, the aircraft will turn left or right correspondingly.

Left side flying and right side flying control

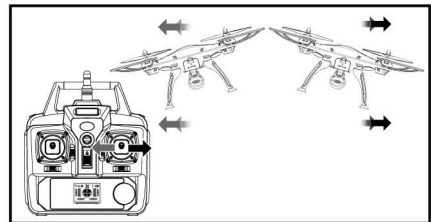

When the right joystick (Turning Rudder) is pushed towards the left or right, the aircraft will fly sideward on the left or right correspondingly.

Fine-tuning operation

Forward and backward fine-tuning control

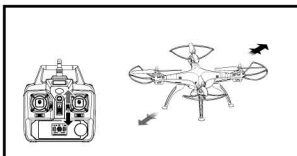

When the aircraft is hovering in the air, in the event that the aircraft is automatically advancing forward or backward, it can be rectified by pressing downwards or upwards the fine-tuning button correspondingly.

Left/right side flying fine-tuning control

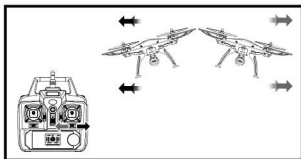

When the aircraft is hovering in the air, in the event that the aircraft is automatically flying sideward on the left or right, it can be rectified by pressing right or left on the fine-tuning button correspondingly.

Left/right side turning fine-tuning control

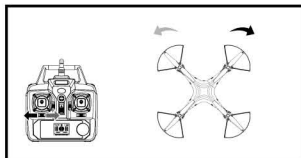

When the aircraft is hovering in the air, in the event that the aircraft is automatically turning left or right, it can be rectified by pressing right or left on the fine-tuning button correspondingly.

Aircraft controlling diagram (mode 2)

Operating direction

Ascending and descending control

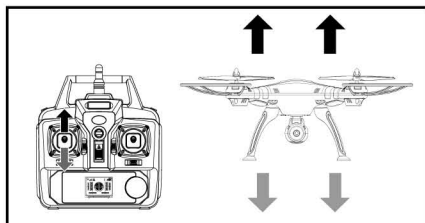

When the left joystick (Accelerator) is pushed upwards or downwards, the aircraft will ascend or descend correspondingly.

Forward and backward control

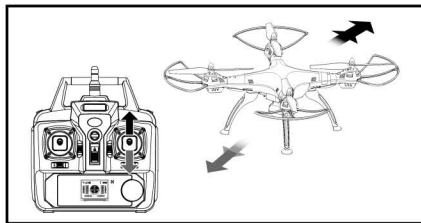

When the right joystick (Turning Rudder) is pushed upwards or downwards, the aircraft will advance forward or backward correspondingly.

Left turning and right turning control

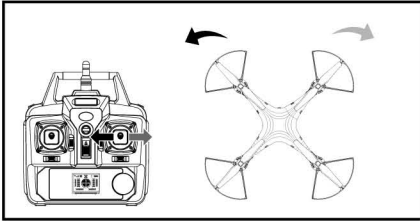

When the right joystick (Turning Rudder) is pushed towards the left or right, the aircraft will turn left or right correspondingly.

Left side flying and right side flying control

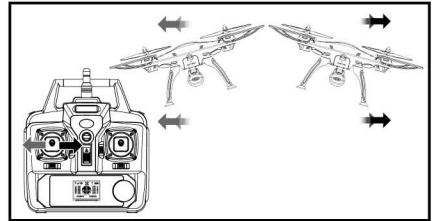

When the left joystick (Accelerator) is pushed towards the left or right, the aircraft will fly sideward on the left or right correspondingly.

Fine-tuning operation

Forward and backward fine-tuning control

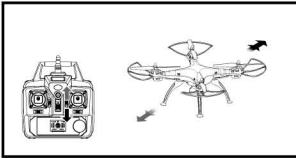

When the aircraft is hovering in the air, in the event that the aircraft is automatically advancing forward or backward, it can be rectified by pressing downwards or upwards the fine-tuning button correspondingly.

Left/right side flying fine-tuning control

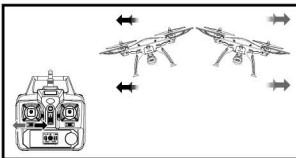

When the aircraft is hovering in the air, in the event that the aircraft is automatically flying sideward towards the left or right, it can be rectified by pressing right or left on the fine-tuning button correspondingly.

Left/right side turning fine-tuning control

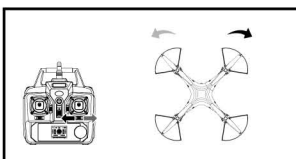

When the aircraft is hovering in the air, in the event that the aircraft is automatically turning left or right, it can be rectified by pressing right or left on the fine-tuning button correspondingly.

Flight preparation and switching off of the aircraft

I. Flight preparation

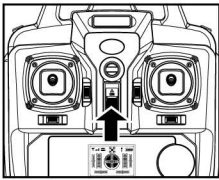

Step 1: Open up the power supply switch of the remote control.

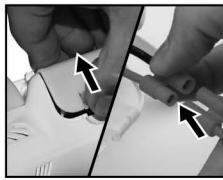

Step 2: Open battery cover, and connect battery connector with dash receiver.

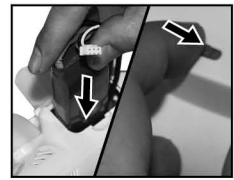

Step 3: Enclose battery into the fuselage, after closing battery cover, turn on the switch on the bottom of aircraft.

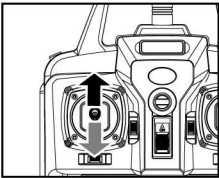

Step 4: Push the left lever (accelerator) to the highest point and then reset to the lowest point. When the indicator lights in the aircraft change from quick flashing to the continuous lighting, it means that the aircraft goes into the flight standby mode.

II. Switching on the aircraft

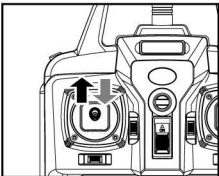

Method 1: push the left lever (accelerator) to the highest point and then reset to the center, the ventilation blade of aircraft starts rotating slowly.

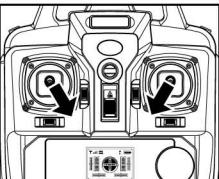

Method 2: Move the left and right joysticks inwards in an internal loop of "8" for 1 second, the ventilation blade of aircraft starts rotating slowly.

III. Switching off the aircraft

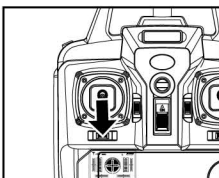

Method 1: Push the left joystick (Accelerator) to the lowest level and stay there for 2 to 3 seconds, the aircraft can then be switched off.

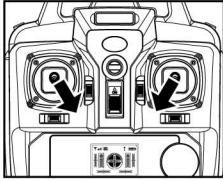

Method 2: Move the left and right joysticks inwards in an internal loop of “8” for 1 second, and the aircraft can be switched off.

Product features

I. Low-voltage protection:

When the four indicator lights at the bottom of aircraft start flicking, it means that the aircraft's battery power is low. At this time, the aircraft will initiate the height-limiting function and will drop to certain safety height.

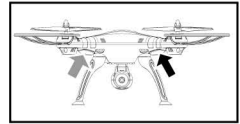

II. Overcurrent protection:

When the aircraft encounters direct impact from foreign object or is stuck under the circumstances in which its blades are rotating, the electric circuit of the aircraft will enter into the overcurrent protection mode.

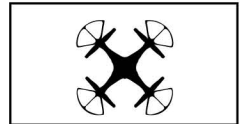

III. Level calibration function:

Place the aircraft on a levelling surface and at the same time, push both left and right joysticks to the lower right corners and stay there for 2 to 3 seconds; the normal light indicator on the aircraft will blink rapidly, and it will return back to the normal status after about 2 to 3 seconds. The level calibration is successful.

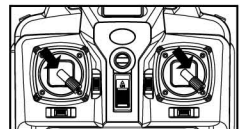

IV. 3D overturning function:

When you are familiar with the basic actions, you can proceed to explore even more exciting and risky overturning actions. Fly the aircraft to a height of above 5 m from the ground, press against the upper right corner button (Overturning Button) on the remote control and simultaneously push the right joystick to the highest level of Front/Back/Left/Right, the aircraft will now be executing the Front/Back/Left/Right overturning function.

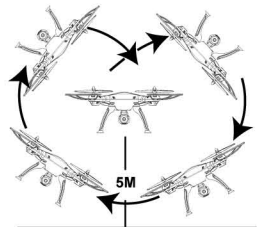

Note: When the batteries are fully charged, it will have the best overturning effect.

V. Pressure hovering height adjustment function:

After using the left joystick (Accelerator) to control the ascending / descending flight of the aircraft, free up the left joystick (Accelerator) and the aircraft will still hover at that height when the joystick is free.

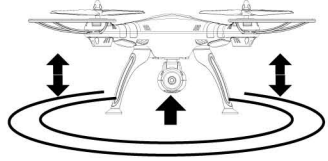

VI. Headless function:

1. Defining forward direction:

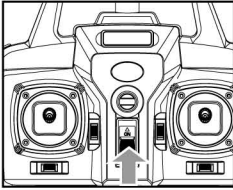

1. Open up the power supply switch of the remote control.

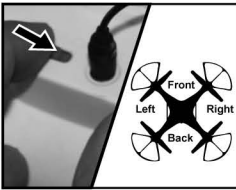

2. After connecting the aircraft to the power supply, push the switch to “NO” location, and adjust the specified direction of the aircraft’s head under the headless mode as the new forward direction.

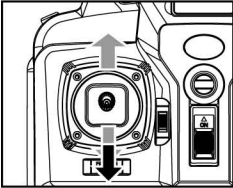

3. Push the accelerator joystick of the remote control to the highest level and then, pull back into the lowest level. When the remote control issues a long beep sound, it means the frequency and defining forward direction functions are completed.

2. Toggling between headless function and normal function:

1. When the aircraft has completed its matching of frequency, the default of the aircraft is normal mode.

At this time, the light indicator on the aircraft is in the long blinking mode. When pressing and holding on to the left upper corner of the headless function toggle button for 2 seconds, the remote control will issue a “Di, Di, Di,” sound indicating it has entered into the headless mode. In subsequent long pressing on the same button for 2 seconds, upon hearing a long “Di” sound, the aircraft has exited from the headless mode. In the headless mode, the four lights on the aircraft is slowly blinking. Every blink is within 4 seconds)

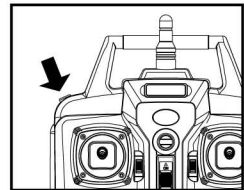

2. Under the headless mode, the operator does not require to differentiate the head position of the aircraft, and he just needs to control the aircraft using the joystick's direction of the remote control.

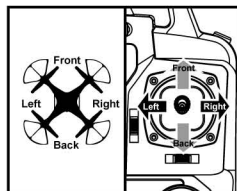

3. Rectification for the defining forward direction function:

1. When the aircraft encounters a direct impact with foreign objects in the headless mode, if there is an occurrence of deviation of the defined direction, it is only required to push the accelerator and the direction joystick to the left bottom corners simultaneously after rectifying the flying direction of the aircraft in the correction direction. When the light indicator of the aircraft is in a long "ON" mode after slowly blinking for 3 seconds, it indicates the rectification is complete.

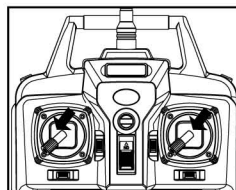

Battery replacement and charging method

Steps of battery replacement:



1. Turn off aircraft's power supply, and push the switch to "OFF".

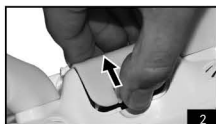

2. Open aircraft's battery cover backward.



3. Connect battery interface with dash receiver.



4. After battery replacement, fasten the battery cover again.

Steps of battery charge:



1. Connect battery switch with charger.



2. Connect charger to power supply socket.

Balanced charger:

1. Insert adapter's DC outlet into import socket of balanced charger. Red light of balanced charger will light on.
2. Insert three-position balanced plug of power battery to output end of charger. Green light of balanced charger will light on. When green light extinguishes, it means the end of battery charging. (Charging time is less than 200 minutes)

Note: if power battery inserts into the charger, the light has no change. It indicates that this battery is full energy. There is no need to recharge.

The charging time is less than 200 minutes; In hover flight conditions longer than 9 minutes!

Cautions when charging:

1. When charging, please put this product on a dried or ventilated area and keep it far away from heat source or explosive product.
2. When charging, please remove the batteries from the quadcopter. Then charging process should be supervised by an adult so as not to cause an accident.
3. When finish flying, please do not charge the battery if the surface temperature is still not cool. Otherwise it may cause a swollen battery or even a fire hazard.
4. Please make sure that you use the original USB charging cable provided. When the battery has been used for a long time, or appears to be swollen, please replace them.
5. A battery when not in use for a long time will lose its charge automatically. Charging or discharging too often may reduce the life of the battery.

Steps of fan blade's installation/ disassembly of aircraft

Steps of fan blade's disassembly:



1. Rotate and back out fan blade cover in anti-clockwise direction as shown in figure (1) .



2. Rotate blade lockstitch for about 90° in the anti-clockwise as figure(2) till the iron shaft point to the opening of blade lockstitch.



3. Get iron shaft out and pull blade lockstitch upward as figure (3) shows.



4. Pull out fan blade upward as shown in figure (4).

Installation steps of fan blade:

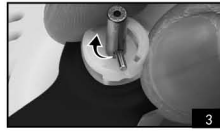
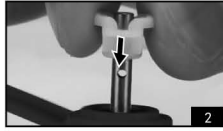

1. Insert fan blade into principal axis pipe as shown in figure (1)
2. Install the blade lockstitch inside the quill as figure (2) shows to ensure that the gap of blade lockstitch aligns at the hole on the quill.
3. Install the iron shaft inside and rotate blade lockstitch for about ninety degrees in the clockwise direction shown in figure (3).
4. Rotate and twist fan blade cover in clockwise direction as shown in figure (4).

Rectification procedures

Problem	Reason	Solution
The aircraft has no response	<ol style="list-style-type: none"> 1. The aircraft has entered into lowvoltage protection. 2. When the power of the remote control is weak, the power light indicator will blink. 3. The channel selection of the remote control does not match with the aircraft's coding. 	<ol style="list-style-type: none"> 1. Charge up the aircraft. 2. Change the batteries of the remote control. 3. Adjust the channel of both the remote control and aircraft such that they are in synchronized mode.
The flight response of the aircraft is not sensitive	<ol style="list-style-type: none"> 1. The power of the remote control is weak. 2. There is an interference with the same frequency as that of the remote control. 	<ol style="list-style-type: none"> 1. Change the batteries. 2. Change to a place where there is no interference with the same frequency.

Problem	Reason	Solution
The aircraft is flying towards its side in one direction during hovering	1. The aircraft is not calibrated level to the ground.	1. Re-adjust the calibration until the aircraft is level to the ground. For further details, please refer to Point III of Page 12 (Level Calibration Function).
In the headless state, it is biased towards the front direction	1. Many collisions may cause head biasness.	1. Re-define the front direction. For further details, please kindly refer to Point VI of Page 13 and 14 (Headless Function).

Accessories (Optional)

You can choose your favourite optional accessories as below. In order to make it easier for the customers to choose and purchase, we have specially offered each and every accessory. The accessories can be purchased through the local distributors. Please kindly specify the colours during your purchase.



X8HC-01
Upper body
(Golden)



X8HC-02
Lower body
(Golden)

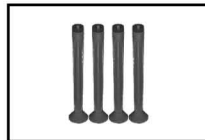

X8HC-03
Base stand
(Black)

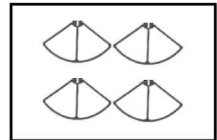

X8HC-04
Protective gear
(Black)



X8HC-05
Rotating blades
(Black)



X8HC-06
Reversing blades
(Black)



X8HC-07
Ornament part
(Black)



X8HC-08
Protective gear
(Black)



X8HC-09
Motor A
 (Red and blue lines)



X8HC-10
Motor B
 (Black and white lines)

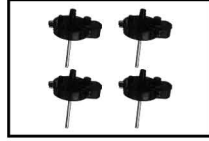

X8HC-11
Main stand



X8HC-12
Blade cover

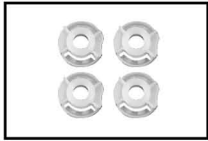

X8HC-13
Blade lockstitch

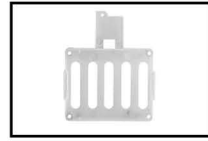

X8HC-14
Base of dash Receiver



X8HC-15
Motor holder
 (Golden)



X8HC-16
Battery cover
 (Golden)

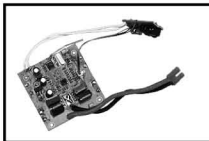

X8HC-17
Receiver board



X8HC-18
Battery



X8HC-19
Charge box

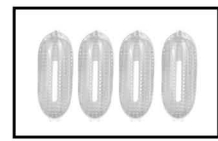

X8HC-20
Lamp cover



X8HC-21
Remote control



X8HC-22
Camera

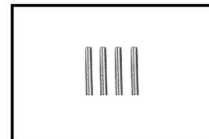

X8HC-23
Iron shaft



X8HC-24
Card reader

Product descriptions

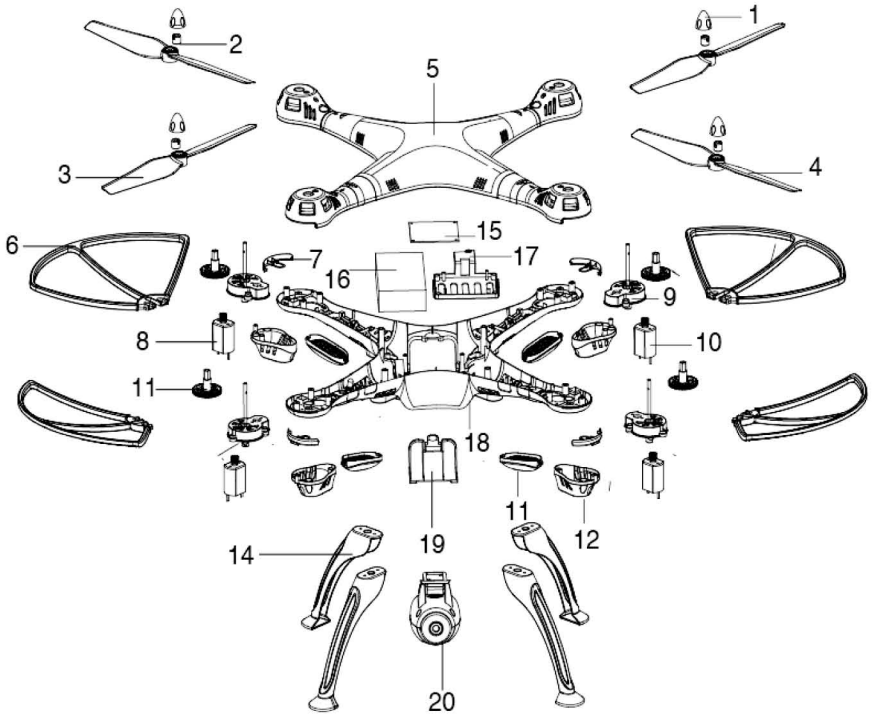

Code	Description	Quantity	Code	Description	Quantity	Code	Description	Quantity
1	Blade cover	4	8	Cear	4	15	Receiver board	1
2	Blade lockstitch	4	9	Main stand	4	16	Battery	1
3	Reversing blades	2	10	Reversing motor	2	17	Base of Dash Receiver	1
4	Rotating blades	2	11	Rotating motor	2	18	Lower body	1
5	Upper body	1	12	Motor cover	4	19	Battery cover	1
6	Protecting frames	4	13	Light boards	4	20	Camera	1
7	Ornament part	4	14	Landing skids	4			

Main specifications

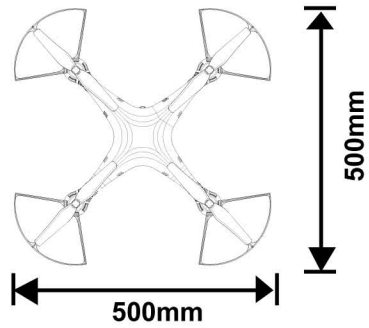
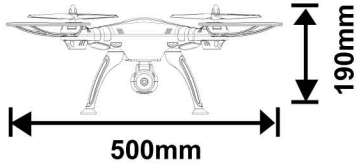

Aircraft's Length:500mm Aircraft's Width:500mm
Aircraft's Height:190mm Motor's Model: 132
Battery: 7.4V/2000mAh lithium battery



SPECIFICATIONS AND COLORS OF CONTENTS MAY VARY FROM PHOTO.

The company has the right of final interpretation
of this instruction manual statement.